

Article number: 204360M12125D3S

Description: E+G levelling foot
GN 43-60-M12-125-D3-S

Note: S Without nut, External hexagon at the bottom

Measures

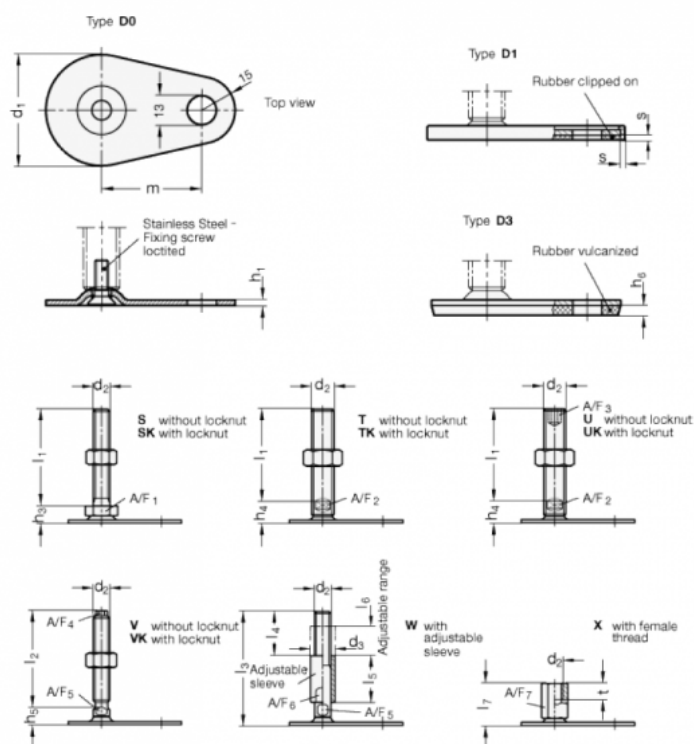

A/F1 = 17

s =

d1 = 60

d2 = M12

h1 = 2.5

h3 = 11

h6 = 4.5

l1 = 125

m = 50